

PRODUCT TECHNICAL DATASHEET

BG30/2204

36V 36V DC

New NEW

Brushless BRUSHLESS



CODE	DESCRIPTION	PCS/PALLET
BG30/2204	Electromechanical BRUSHLESS motor, low voltage, super intensive use, with native encoder onboard, irreversible ideal for sliding gates up to 2200 kg with built-in digital controller B70 series, magnetic limit switch.	40

PRODUCT TECHNICAL SPECIFICATIONS	
Max gate weight	2200 kg
Power line supply	230V AC - 50Hz
Motor power supply	36V
Power rating	470W
Frequency of use	Intensive use
Thrust	50 - 1700N
Operating temperature	-20+55°C
Protection level	IP43
Reductor Type	Irreversible
Manoeuvre speed	10 m/min (0.16 m/s)
Limit switch	Magnetic
Onboard control unit	B70/1DCHP
Encoder	Digital native encoder + magnetic digital SENSORED, 4096 PPR
Batteries recovery	Optional 2 external battery 12V 4,5AH
Type exit gear	Z17/mod 4
Operating cycles per day (opening/closing - 24 hours no stop)	1000
Maximum dimension product in mm (L x W x H)	346 x 180 x 362
Product weight packed (Kg)	20,1

PRODUCT DIMENSIONS AND PREPARING FOR INSTALLATION

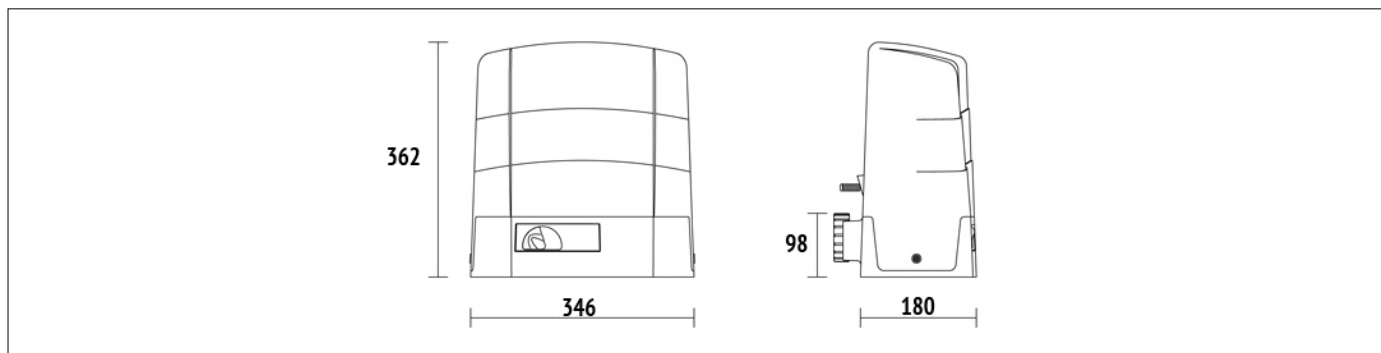

DIMENSIONS

PRODUCT PREPARING FOR INSTALLATION

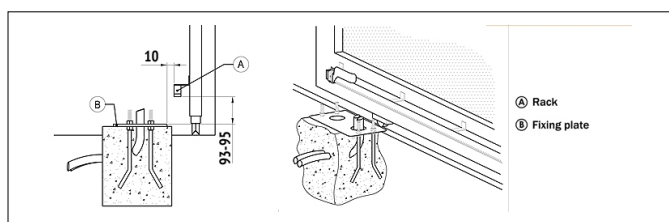

PREDISPOSITION FOR STANDARD INSTALLATION

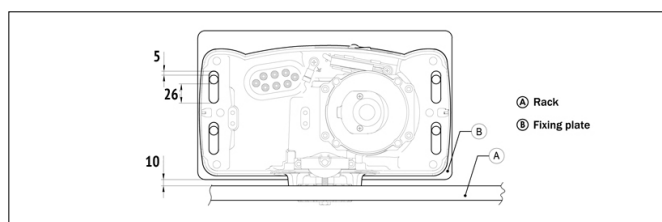

PREDISPOSITION FOR STANDARD INSTALLATION

PRODUCT ACCESSORIES



B71/BCHP/EXT
Kit for emergency batteries charger for brushless digital controller EDGE1/BOX - B70/1DCHP 36V DC with plug-in card, with 2 recovery batteries 12V DC, 4.5 Ah. Box case included.



B71/BCHP/BOX
Kit for emergency batteries charger for brushless digital controller EDGE1/BOX - B70/1DCHP 36V DC. Box case included and without recovery batteries

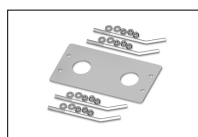

KT215
Fixing plate with stay bolts and screws G30 series.

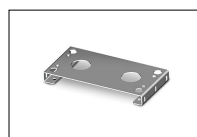

KT222
Raised fixing plate for G30 series (+3,5 cm).



GA550
Galvanised steel rack 22x22x1000 module 4.

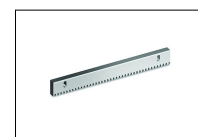

GA551
Galvanised steel rack 30x12x1000 module 4 with spacers and screws.



GA554
Pocket of 6 spacers (2,5 Cm) and screws.

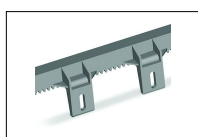

GA553
Nylon rack module 4 with 6 connectors L.1000.

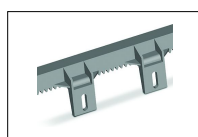

GA557
Roger Technology nylon rack module 4 with 6 connectors L.1000.



LT328
Z17 mod. 4 Pinion with increased thickness H.38 for series R30 - G30 - E30

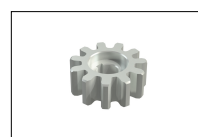

LT331
Pinion Z11 mod. 6 only for series G30 - BG30

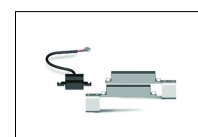

MC775
Kit magnetic limit switch for control unit H70/103AC, H70/104AC, B70/1DC, B70/1DCHP.



R99/C/001
Signboard "Automatic Opening".